

Machining Recommendations

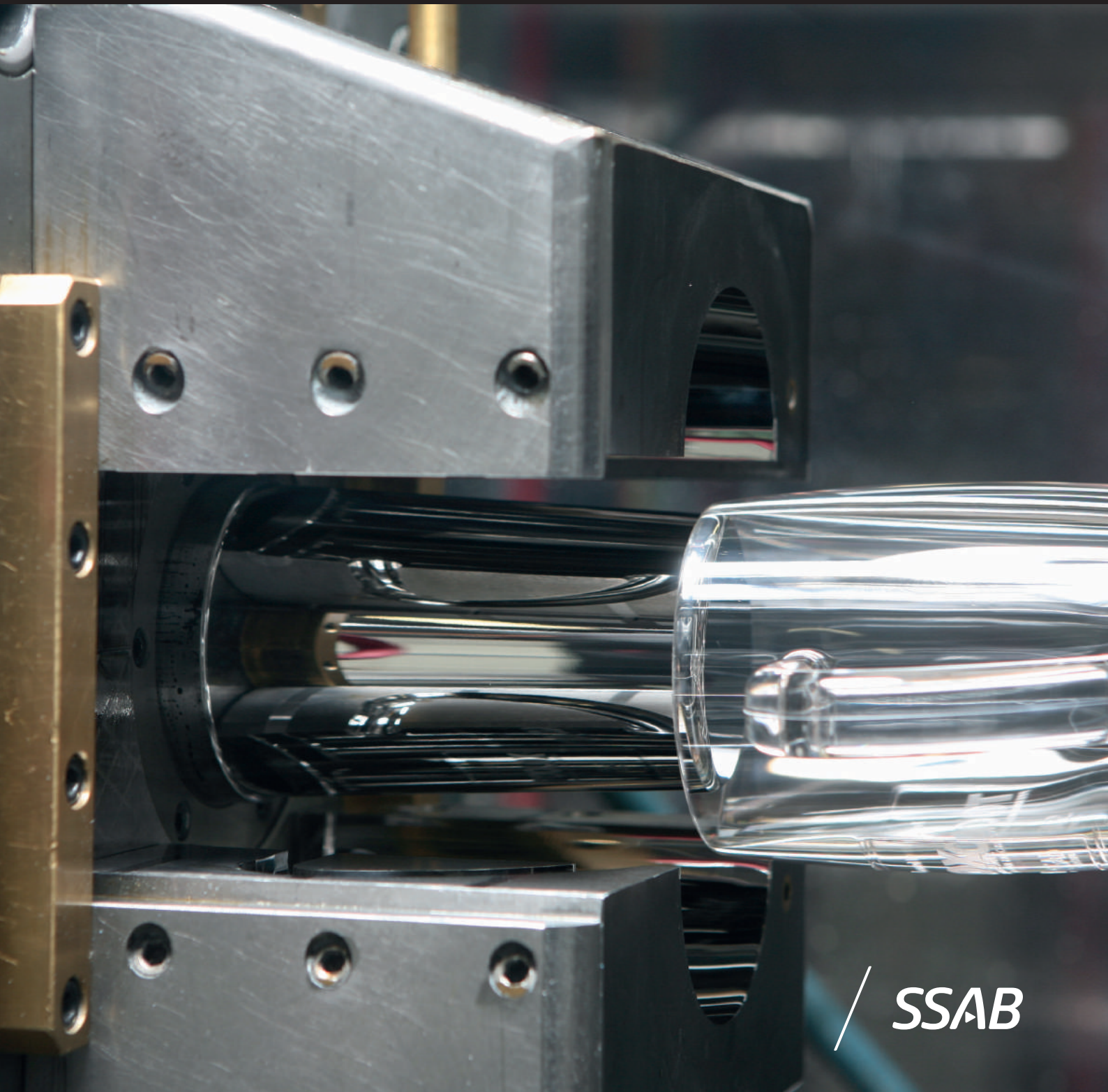

WHAT IS TOOLOX?

Toolox® is a modern quenched and tempered prehardened tool and machine steel, delivered with measured and guaranteed mechanical properties. The basic idea is to save you time by delivering Toolox heat treated and ready to use. It provides you with lower costs, reduced risks and saves you valuable time in your production process due to its excellent machinability. This combined with the benefit of working with the hardest pre-hardened tool steel in the world gives you a simple to use material with a wide variety uses.

Toolox is based on the low carbon metallurgical concept found in Hardox and Weldom, but it is specially developed for tools and machine components working at high temperatures. It has excellent fatigue properties and you can actually increase the surface hardness with nitriding or PVD coatings to gain more control over the service life of your tools or components.

SHORTER LEAD TIME FROM CONCEPT TO PRODUCTION

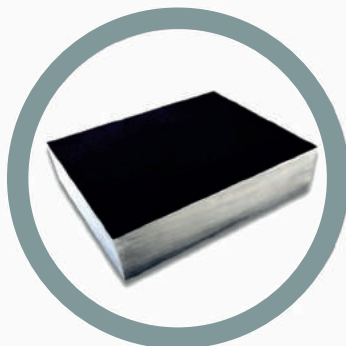

1. Your customer has an idea

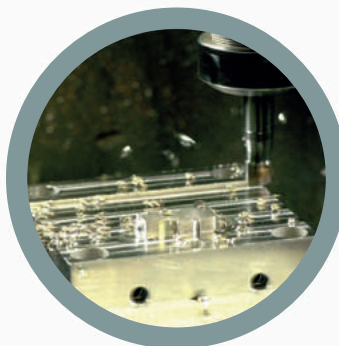

2. Manufacturing



3. Transport



4. Quenching and tempering



5. Adjusting



6. Production

DRILLING RECOMMENDATIONS

HSS-DRILL

Use only HSS drills there you have unstable machine conditions, if the machine conditions are good you have several choices of solid/brazed cemented carbide drill or drills with exchangeable heads.

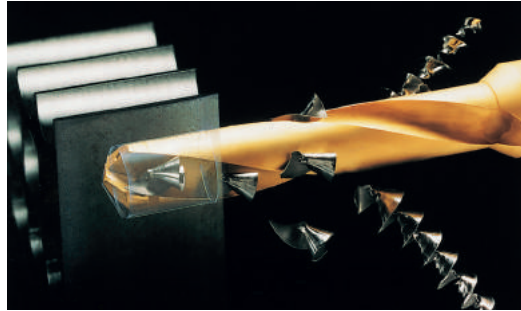

HSS-Co



Use an HSS-Co drill (8% Co) with a small helix angle and a robust core that can withstand high torques.

HSS HSS-E HSS-Co



Individual holes can be drilled with an ordinary HSS drill. For rational production, either a micro-alloyed (HSS-E) drill is recommended.

	Toolox 33	Toolox 40	Toolox 44
Vc m/min	~ 15	~ 9	~ 7
Dc (mm)	Feedrate (mm/min and speed (rpm)		
5	0,10/950	0,05/570	0,05/445
10	0,10/475	0,10/290	0,09/220
15	0,16/325	0,16/190	0,15/150
20	0,23/235	0,22/150	0,20/110
25	0,30/195	0,28/110	0,25/90
30	0,35/165	0,35/90	0,30/75
*35	0,40/136	0,40/80	0,35/63
*40	0,45/119	0,45/70	0,40/55

* WHEN USING LARGE DRILL DIAMETER (>30 MM), THINK ABOUT FOLLOWING:

1. The machine need to be large and stable to raise sectinal forces.
2. No play in the spindle.
3. Make sure that the workpiece is well clamped.
4. Check the motor output is equal or greater than 7,5 kW.

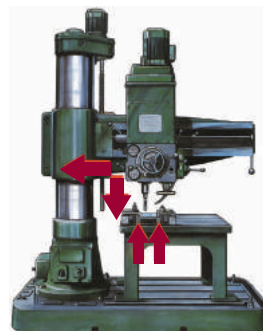

ADVICE FOR REDUCING VIBRATIONS AND INCREASING THE LIFETIME ON THE DRILL

- ▶ Minimize the distances to the column and between to drill tip and the workpiece
- ▶ Don´t use longer drill than necessary
- ▶ Always use metal supports
- ▶ Clamp securely
- ▶ Solid and firm table
- ▶ Use always coolant
- ▶ Coolant mix 8-10 %
- ▶ Just before the drill breaks through, disengage the feedrate for about a second,play/springback can otherwise snap the drill tip, Re-engage the feedrate when the play/springback has ceased

SOLID CEMENTED CARBIDE DRILL

For stable machine conditions and with internal coolant. Coolant mix 8-10 % for all drilling.



Diameter	Vc (m/min)	Toolox 33 65-90		Toolox 40 50-70		Toolox 44 40-65	
		min-max	startvalue	min-max	startvalue	min-max	startvalue
	fn (mm/rev)						
	3.0 -5.0	0,08-0,15	0,10	0,06-0,12	0,08	0,06-0,11	0,07
	5.01-10.0	0,09-0,16	0,12	0,08-0,15	0,11	0,08-0,13	0,10
	10.01-15.0	0,16-0,22	0,18	0,14-0,20	0,16	0,12-0,18	0,15
	15.01-20.0	0,22-0,28	0,25	0,16-0,24	0,20	0,16-0,20	0,18

*drilling 7x Dc, reduce the feed ~20 %

*drilling with external coolant ,reduce the speed and feed ~ 20 %

DRILLS WITH EXCHANGEABLE DRILL HEADS OR BRAZED CEMENTED CARBIDE DRILL

For stable machine conditions and with internal coolant.



Diameter	Vc (m/min)	Toolox 33 50-80		Toolox 40 50-65		Toolox 44 40-60	
		min-max	startvalue	min-max	startvalue	min-max	startvalue
	fn (mm/rev)						
	7,5-12,0	0,10-0,16	0,13	0,08-0,15	0,12	0,08-0,14	0,11
	12.01-20.0	0,15-0,23	0,20	0,12-0,22	0,17	0,12-0,20	0,15
	20.01-25.0	0,18-0,27	0,22	0,15-0,25	0,19	0,14-0,22	0,17
	25,01-30.0	0,20-0,30	0,24	0,17-0,27	0,21	0,16-0,25	0,19

* Drilling with 25-30xD reduce the feedrate with ~15-20 %

* The recommendation is that atleast have 25 bars pressure on the waterpump.

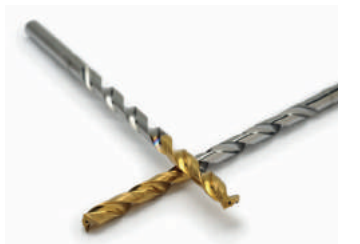

LONG HOLES DRILLING WITH 16-20XD

For stable machine conditions and with internal coolant.

Diameter	Vc (m/min)	Toolox 33 50-70		Toolox 40 50-65		Toolox 44 40-60	
		min-max	startvalue	min-max	startvalue	min-max	startvalue
	fn (mm/rev)						
	6.0	0,12-0,16	0,14	0,10-0,15	0,12	0,08-0,14	0,11
	8.0	0,14-0,20	0,16	0,11-0,18	0,14	0,10-0,18	0,13
	10.0	0,17-0,24	0,19	0,13-0,22	0,16	0,12-0,21	0,15
	12,0	0,18-0,26	0,20	0,15-0,24	0,18	0,14-0,23	0,17

* The cutting data on this page has been formulated in co operation with Seco Tools.

MILLING RECOMMENDATIONS

CLAMPING

Toolox has very low level of residual stresses. To get the full effect make sure to use deformation free clamping. If blanks are gas cut, mill off 5-10mm from the gas cut edge to get a blank free from residual stresses.

The machinability of Toolox has been improved. During milling you will notice it as the chips produced are very bluish. We have modified the carbide morphology as compared to traditional tool steels, using less carbon in Toolox. Thereby the heat generated during milling is transferred into the chip and not into the cutting edge/workpiece.



MILLING ADVICE

- ▶ Position the cutter off-centre (to the left) to achieve a thicker chip at the entry and to avoid thick chip on the exit.
- ▶ Avoid cutting through the centre line of the cutter, as this could generate vibration.
- ▶ Always use down milling (climb milling).
- ▶ The recommendation is that the radial engagement of the cutter (a_e) shall be 25 or 75-80 % of the diameter.

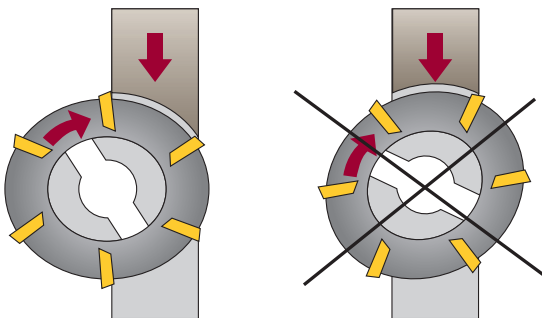
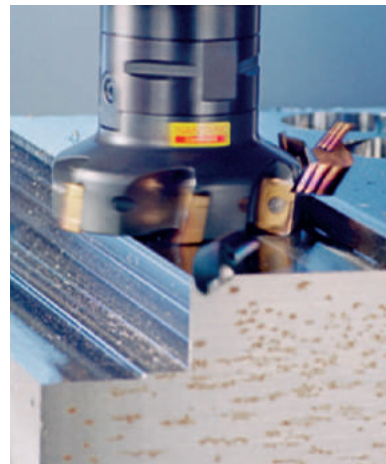

If you entering the workpiece with the rolling into cut method the chip thickness on the exit is always zero, and it will help to give a longer tool life.

Rolling into cut method

Wear after 800 passes



Straight into the workpiece

Wear after 390 passes



Rolling into cut method

$$\text{Prog. rad.} = \left(\frac{D_e}{2}\right) + 2$$

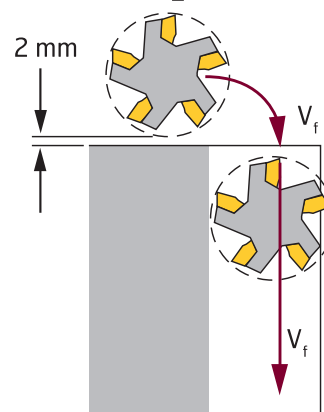

INSERTS GRADES FOR MILLING

	ISO	ANSI	
P	01	C8	↑
	10	C7	
	20		
	30	C6	
	40		
	50	C5	↓
M	10		↑
	20		
	30		
	40		↓
K	01	C4	↑
	10	C3	
	20	C2	
	30	C1	
	40		↓
H	01	C4	↑
	10	C3	
	20	C2	
	30	C1	↓

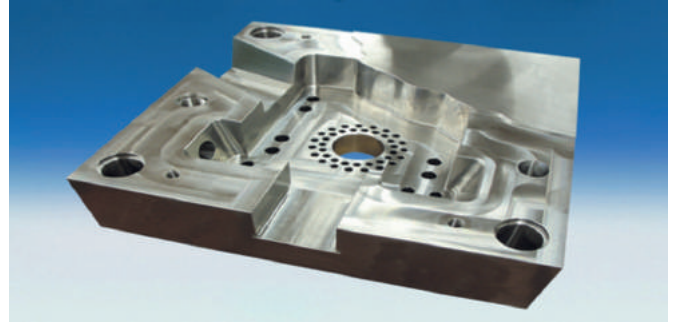

- ↑ Wear resistance
- ↓ Toughness

- P** ISO P = Steel
- M** ISO M = Stainless steel
- K** ISO K = Cast iron
- H** ISO H = Hardened steel



* Example insert grade 1030.

“The last 2 numbers in the insert grade indicate were in this scale the insert belong, if the insert have wear or toughness resistance.”

INSERT GEOMETRY

The macro geometry affects many parameters in the cutting process. An insert with strong cutting edge can work at higher loads, but it will also generate higher cutting forces, consumes more power and generate more heat.



Parameter	Geometry		
	L	M	H
Edge strength			
Cutting forces			
Power consumption			
Max chip thickness			
Heat generated			

* Use inserts grade P 30-50 with light cutting geometry and a coarse - pitch cutter if the machine power is low and with unstable machine conditions.

FACE MILLING RECOMMENDATION

Round inserts have strong cutting edges and are good to use when the surface has holes and cavities etc.



Recommendation for average machine conditions with a 45° setting angle

Vc (m/min)	Toolox 33 180-220		Toolox 40 140-180		Toolox 44 120-160	
	min-max	startvalue	min-max	startvalue	min-max	startvalue
Insert grade P30	0,15-0,35	0,25	0,15-0,35	0,25	0,15-0,35	0,25

Recommendation for average machine conditions with round inserts

Vc (m/min)	Toolox 33 180-220		Toolox 40 170-210		Toolox 44 140-180	
	min-max	startvalue	min-max	startvalue	min-max	startvalue
Insert grade P30	0,10-0,25	0,15	0,10-0,25	0,15	0,10-0,25	0,15

SHOULDER MILLING RECOMMENDATION



Recommendation for average machine conditions with a 90° setting angle

Vc (m/min)	Toolox 33 180-220		Toolox 40 140-180		Toolox 44 120-160	
	min-max	startvalue	min-max	startvalue	min-max	startvalue
Insert grade P30	0,12-0,25	0,17	0,12-0,25	0,17	0,12-0,25	0,17

END MILLING RECOMMENDATION FOR SOLID CEMENTED CARBIDE TOOL



Slot milling recommendation				Shoulder milling recommendation			
	Toolox 33	Toolox 40	Toolox 44	Toolox 33	Toolox 40	Toolox 44	
Vc (m/min)	85-110	75-100	70-95	200-230	180-210	160-190	
Feedrate (fz)	min-max	min-max	min-max	min-max	min-max	min-max	
Diameter	3,0-6,0	0,01-0,03	0,01-0,03	0,01-0,03	0,02-0,05	0,02-0,04	0,02-0,04
	8,0-12,0	0,04-0,07	0,03-0,06	0,03-0,06	0,07-0,10	0,06-0,09	0,06-0,09
	14,0-20,0	0,07-0,10	0,06-0,09	0,06-0,08	0,10-0,14	0,10-0,13	0,10-0,12

* If you have possibility, use only compressed air to remove the chip and use weldon chuck for tool over Ø 10.



Slot milling advice

ap (depth of cut) max 0.5x D



Shoulder milling advice

ap (use the whole cutting length)

ae (radial depth of cut) max 0.1 x D

TAPPING RECOMMENDATIONS

With the correct tools all tapping/thread milling operations can be performed in all Toolox grades. We recommend four-flute taps which can withstand very high torque which occurs during tapping in hard materials. If is not critical, the drilled hole can be 3% larger than standard, this will increase the lifetime of the tap.



Tap for blind holes.



Tap for through holes.

* Thread oil or thread paste is recommended as lubricant.

	Toolox 33 7-10	Toolox 40 4-9	Toolox 44 3-5
Vc (m/min)			
Size	Speed (rpm)	Speed (rpm)	Speed (rpm)
M5	445-635	255-570	190-320
M6	370-530	210-475	160-265
M8	270-400	160-360	120-200
M10	220-320	125-285	95-160
M12	185-265	105-240	80-130
M16	140-200	80-180	60-100
M20	110-160	60-140	45-80

* We recommend thread milling for thread below M5 especially in Toolox 40 and 44.



	Toolox 33	Toolox 40	Toolox 44
Vc (m/min)	80-110	60-80	50-70
fz mm	0,03-0,06	0,02-0,05	0,02-0,05

* To manage thread milling, a CNC machine is necessary and the thread should be made in 2 passes.

COUNTERSINKING & COUNTERBORING

Countersinking/boring are best performed using tools which have replaceable inserts. Always use a revolving pilot and use coolant.



Vc (m/min)	Toolox 33 40 - 80	Toolox 40 25 - 70	Toolox 44 20 - 50
Feedrate mm/rev	0,10-0,20	0,10-0,20	0,10-0,20
Dc (mm)	Speed (rpm)		
19	670-1340	420-1175	335-840
24	530-1060	330-930	265-665
34	375-750	235-655	185-470
42	300-600	190-530	150-380
57	225-440	140-390	110-280

* Reduce the cutting data with about 30 % in countersinking.

RESULT FROM OUR OWN TESTS



MACHINE INFO

VMC FADAL 4020 HT modell 1997
 Spindle type ISO 40 taper
 Through spindle coolant
 Spindle speed max 10,000 rpm
 Effect on the spindle motor 16,8 kw
 Torque 303Nm.

The machine used during the tests.

Toolox 33	Tool	Ø	Vc	f	ap	ae	runtime
Shoulder milling	Coromill 490	50	180	0,17	4 mm	13 mm	196 min
Runtime 132 min				Runtime 196 min			

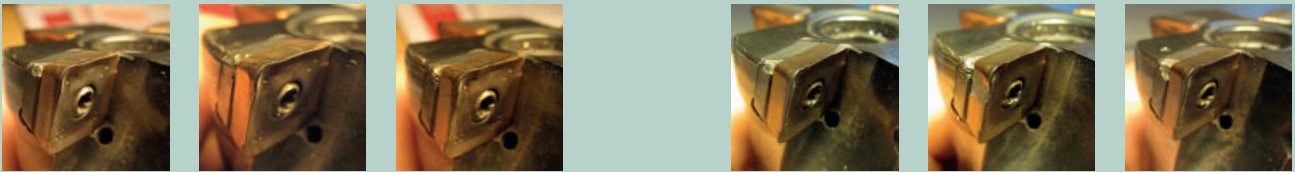

Toolox 40	Tool	Ø	Vc	f	ap	ae	runtime
Face milling	Coromill 345	100	160	0,25	2 mm	68 mm	43 min

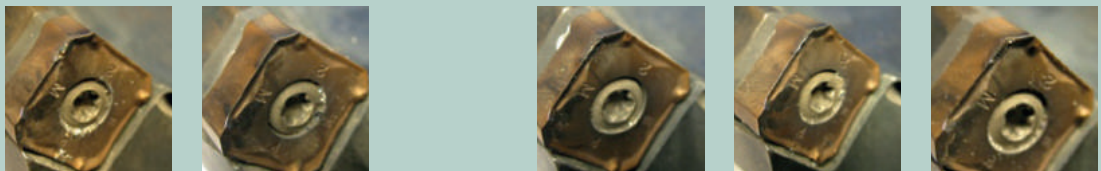

Toolox 44	Tool	Ø	Vc	f	ap	ae	runtime
Face milling	Coromill 345	100	150	0,25	2 mm	61 mm	32 min

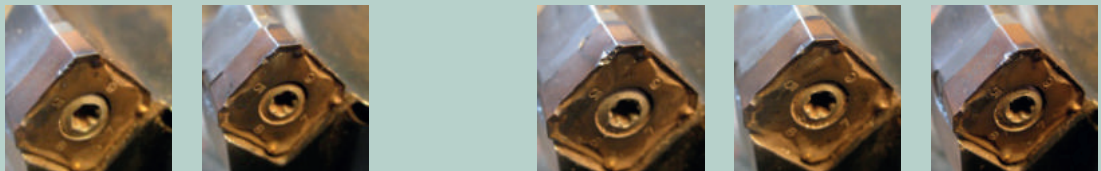

Toolox 44	Tool	Ø	Vc	f	ap	ae	runtime
Shoulder milling	End milling	16	180	0,12	34 mm	1,6 mm	103 min

Photo after 250 passes and with a run-time of 72 min.

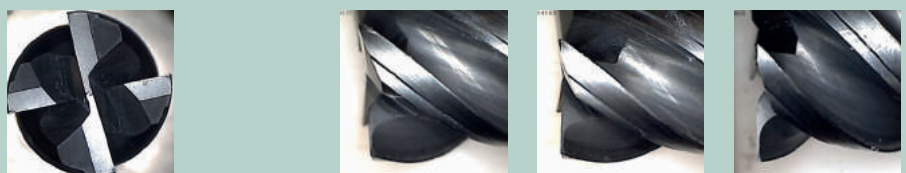

Toolox 33	Tool	Ø	Vc	fn	total	drill depth	coolant flow
Drilling/ blind holes	Corodril 840	6,8	80	0,12	1105	23 mm	1,9 l/min

After 264 drilled holes



After 1105 drilled holes



Good chip formation



Toolox 40	Tool	Ø	Vc	fn	total	drill depth	coolant flow
Drilling/ blind holes	Seco Feedmax	4,3	70	0,12	608	16 mm	0,2 l /min

After 608 drilled holes

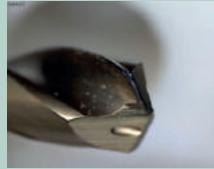
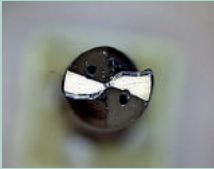

Toolox 44	Tool	Ø	Vc	fn	total	drill depth	coolant flow
Drilling/ blind holes	Seco Feedmax	4,3	60	0,06	438	15 mm	0,2 l /min

After 438 drilled holes

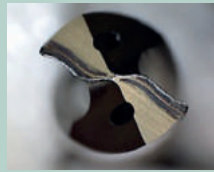

Toolox 40	Tool	drill Ø	Ø	Vc	thread depth	Total
Tapping / blind holes	Manigley 131/3 DUO	4,3	M5	11	12 mm	330

Toolox 40	Tool	drill Ø	Ø	Vc	thread depth	Total
Tapping / blind holes	Manigley 131/3 DUO	10,2	M12	8	24 mm	217

Toolox 44	Tool	drill Ø	Ø	Vc	thread depth	Total
Tapping / blind holes	Manigley 105/4 DUO	4,3	M5	3	10 mm	183

After 183 threaded holes



Toolox 40	Tool	drill Ø	Ø	Vc	thread depth	Total
Tapping / blind holes	Rekord 2 DF-NI TICN	14,2	M16	6	25 mm	276

After 276 threaded holes

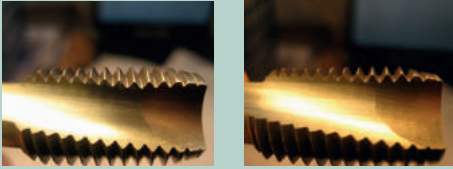

TOOL RECOMMENDATIONS FOR TOOLOX

DRILLING IN TOOLOX

Tool name	Article nr	Diameter range
Seco Feedmax	* SD203A-12.0-36-12R1	2,0-20,0

*Example for Ø 12

Solid cemented carbide drill

Supplier: Seco
Sweden
www.secotools.com



Tool name	Article nr	Diameter range
Seco Feedmax	* SD216A-12.0-180-12R1	3,0-14,10

*Example for Ø 12

Long holes drilling with 16-20xD Solid cemented carbide drill

Supplier: Seco
Sweden
www.secotools.com



Tool name	Article nr	Diameter range
Cordrill R840 Delta C	R840-xxxx-30-A1A	3,0-20,0

Solid cemented carbide drill

Supplier: Sandvik Coromant AB
Sweden
www.sandvik.coromant.com



Tool name	Article nr	Diameter range
Crownloc	* SD103-12.00-40-16R7	10,0-25,99

*Example for Ø 12

Drill with exchangeable drill heads Drill heads grade: P

Supplier: Seco
Sweden
www.secotools.com



Tool name	Article nr	Diameter range
Chamdrill	DCM xxx-xxx-xxA-xx.xx	7,5-25,9

Drill with exchangeable drill heads Drill heads grade: IC908

Supplier: Iscar
Israel
www.iscar.com

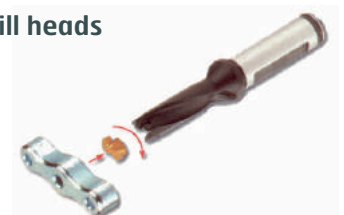

DRILLING IN TOOLBOX

Tool name	Article nr	Diameter range
HSS -E Co 8 Taper Shank Drills, WN 103	832xxxxx	8,0-40,0

High speed steel drill alloyed with 8 % cobalt (HSS-Co 8 %)

Supplier: Alpen-MayKestag
Austria
www.alpenmaykestag.com



Tool name	Article nr	Diameter range
HSS A100	A100xx.xx	0,2-20,0

High speed steel drill standard Only for Toolox 33

Supplier: Dormer
Sweden
www.dormertools.com



TAPPING IN TOOLBOX

Tap for through holes

Tool name	Article nr	Diameter range
105/4 DUO	433xx	M3-M30

HSSE-PM tap with TiCN coating

Supplier: Manigley
Switzerland
www.manigley.ch



Tap for blind holes

Tool name	Article nr	Diameter range
131/3 DUO	433xx	M3-M36

HSSE-PM tap with TiCN coating

Supplier: Manigley
Switzerland
www.manigley.ch



Tap for blind holes

Tool name	Article nr	Diameter range
Rekord 1DF-NI-TiCN	B0459601.xxxx	M3-M10
Rekord 2DF-NI-TiCN	C0459601.xxxx	M12-M24

HSSE tap with TiCN coating

Supplier: Emuge Franken
Germany
www.emuge.de/english

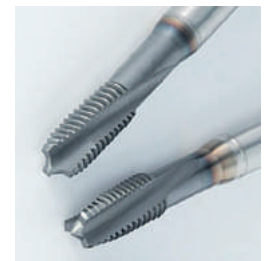

Tap for through holes

Tool name	Article nr	Diameter range
Rekord 1C-Ti-TiCN	B0309601.xxxx	M3-M10
Rekord 2C-Ni-TiCN	C0309601.xxxx	M12-M24

THREAD MILLING IN TOOLOX

Tool name	Article nr	Diameter range
GSF-VHM 2xD IKZ-HB TiCN	GSF333106xxxx	M3-M16

Solid carbide thread milling cutter with TiCN coating

Supplier: Emuge Franken
Germany
www.emuge.de/english



Tool name	Article nr	Diameter range
Solid carbide thread mill	NBxxxxxCxx x.xISO AC	M2-M42

Solid carbide thread milling cutter with TiAlCN coating

Supplier: SmiCut
Sweden
www.smicut.se

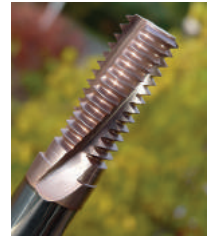

* For information about distributors contact Smicut.

COUNTERBORING IN TOOLOX

Use counterbore with indexable inserts and the inserts grade number shall always finish with H

Tool name	Article nr	Diameter range
WHV counterbore	XWHV-xx.x	18.0-75.0

Supplier: Granlund tool AB
Sweden
www.granlund.com



COUNTERSINKING IN TOOLOX

Use countersink with indexable inserts and the inserts grade number shall always finish with H

Tool name	Article nr	Diameter range
KV countersink	xKV9-xx.x	20,5-60,0

Supplier: Granlund tool AB
Sweden
www.granlund.com



END MILLING IN TOOLOX

Tool name	Article nr	Diameter range
JS 554 Siron-A	JS 554 xxxx	3,0-25,0

Solid end milling cutter with Siron-A coating

Supplier: Alfa Tool / Seco
Sweden
www.alfatool.se
www.secotools.com

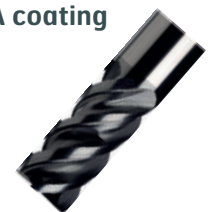

MILLING WITH INSERT IN TOOLOX

Tool name	Article nr	Diameter range
Coromill 345	345-xxxxxx-13x	40-250

Face milling with Coromill 345

Supplier: Sandvik Coromant AB
Sweden
www.sandvik.coromant.com



Tool name	Article nr	Diameter range
Coromill 300	R300-xxxxx-xxx	10-200

Face milling with Coromill 300

Supplier: Sandvik Coromant AB
Sweden
www.sandvik.coromant.com



Tool name	Article nr	Diameter range
Coromill 490	490-xxxxx-xxx	20-250

Shoulder/face milling with Coromill 490

Supplier: Sandvik Coromant AB
Sweden
www.sandvik.coromant.com



INSERT GRADE IN TOOLOX

Tool name	Article nr	Insert grade	Insert geometry
Coromill 300	R300-xxxxx-Px	1010	L-M-H
	R300-xxxxx-Px	1030	L-M-H
Coromill 345	345R-1305x-Px	1010	L-M-H
	345R-1305x-Px	1030	L-M-H
Coromill 490	490R-xxxxxxx-Px	1010	L-M
	490R-xxxxxxx-Px	1030	L-M-H

Use insert grade P1030 for average machine conditions, in very stable machine conditions and with a rigid set-up the insert grade P1010 would be more suitable, especially in Toolox 40 and 44. Then the cutting speed can be increased by approximately 20-30 %.

Supplier: Sandvik Coromant AB
Sweden
www.sandvik.coromant.com

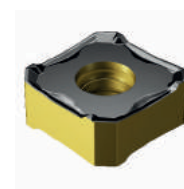

APPLICATION AREAS

PLASTIC MOULD

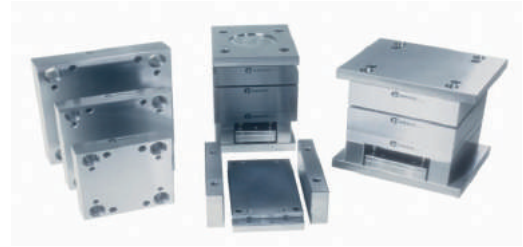
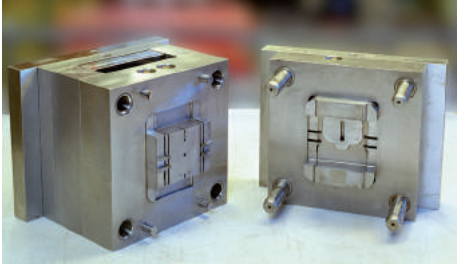

COLD WORKING

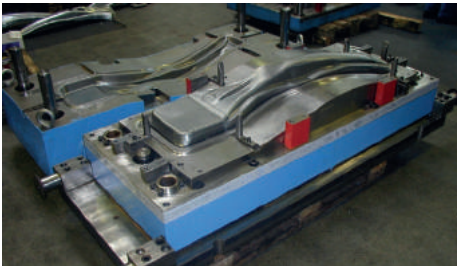

HOT WORKING

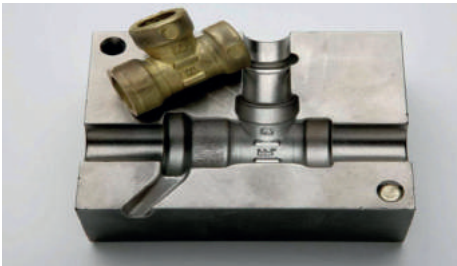

MACHINE COMPONENTS

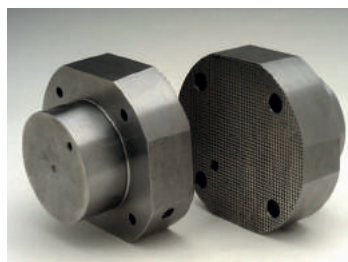

SSAB is a global leader in value added, high strength steel. SSAB offers products developed in close cooperation with its customers to create a stronger, lighter and more sustainable world.

SSAB has employees in over 45 countries and operates production facilities in Sweden and the US. SSAB is listed on the NASDAQ OMX Nordic Exchange, Stockholm. www.ssab.com.

SSAB

SE-613 80 Oxelösund
Sweden

Phone: +46 155-25 40 00

Fax: +46 155-25 40 73

E-mail: contact@ssab.com

www.toolox.com

The SSAB logo consists of the letters 'SSAB' in a bold, blue, sans-serif font. The letters are closely spaced and have a slight shadow effect.